

PATCHBOX® Plus+ System STP / UTP

The PATCHBOX® is the most modern cabling system for network cabinets. It makes conventional cable guides and patch cables simply look old. Thousands of satisfied customers worldwide rely on this patented innovation to make their IT more efficient, faster and more economical.

Technical Specification

STP Cable

Flat Cat.6a Shielded Twisted Pair, ISO/IEC 11801 Channel Class Ea, 500MHz, AWG36, 100% stranded copper, PVC jacket, PoE (802.3af)

UTP Cable

Flat Cat.6a Unshielded Twisted Pair, ISO/IEC 11801 Channel Class Ea, 500MHz, AWG30, 100% stranded copper, PVC jacket, PoE (802.3af)

Connector

RJ45 shielded plug, pins gold plated, snagless booted

Cable length

1.8m covers 30RU

Frame

RAL9005 powder coated steel

Cassette Profiles

Stainless steel, laser-welded

Mounting Rails

Stainless steel, variable from 500mm to 850mm

Plastic Parts

Polyoxymethylene POM

Operating Temperature Range

-20°C – 60°C

Ambient Humidity Non-Condensing

10% -90%

Gross Weight

11.86kg

Packaging Dimensions

760mm x 590mm x 50mm WxDxH

HS-Code

8544 4210

For Customers in Australia & New Zealand

STP patch cords are compliant with AS/CA S008:2010 A1:2014

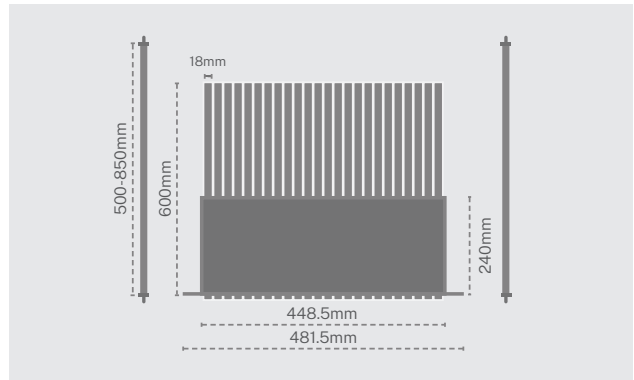
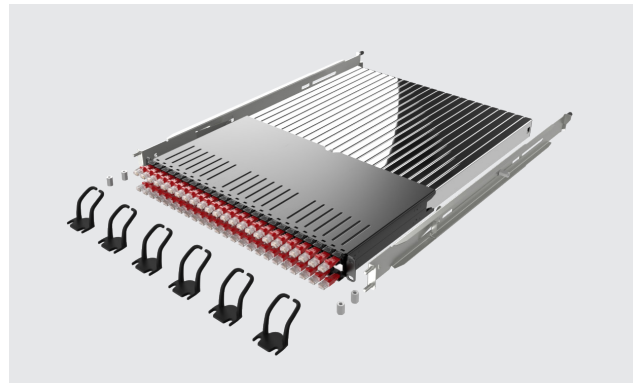

Items included

- 24 x PATCHBOX Plus+ STP / UTP Cassette with Cat.6a cable
- 1 x PATCHBOX Plus+ Frame
- 6 x Patchcatch
- 2 x adjustable mounting rails incl. hex nuts
- 2 x DIN A5 tear-off ID Labels (96 Labels)

Shielded Twisted Pair (STP) Variants

Product Code	Cable Color
P60STPXC6AX24K	Black
P60STPXC6AX24B	Blue
P60STPXC6AX24G	Green
P60STPXC6AX24R	Red
P60STPXC6AX24W	White
P60STPXC6AX24Y	Yellow
P60STPXC6A24GY	Grey
P60STPXC6AX24V	Violet

Unshielded Twisted Pair (UTP) Variants

Product Code	Cable Color
P60UTPXC6AX24K	Black
P60UTPXC6AX24B	Blue
P60UTPXC6AX24G	Green
P60UTPXC6AX24R	Red
P60UTPXC6AX24W	White
P60UTPXC6AX24Y	Yellow
P60UTPXC6AX24V	Violet

PATCHBOX® Plus+ System Fiber Optic

The PATCHBOX® is the most modern cabling system for network cabinets. It makes conventional cable guides and patch cables simply look old. Thousands of satisfied customers worldwide rely on this patented innovation to make their IT more efficient, faster and more economical.

Technical Specification

OS2 Cable

OS2 RBS 9μ/125μ, G.657.B3, LSZH, Yellow, Single-Mode

OM4 Cable

OM4 RBS 50μ/125μ, LSZH, Erika Violet, Multi-Mode

Connector

LC Duplex - LC Duplex / LC Duplex - SC Duplex

Cable length

1.8m covers 30RU

Frame

RAL9005 powder coated steel

Cassette Profiles

Stainless steel, laser-welded

Mounting Rails

Stainless steel, variable from 500mm to 850mm

Plastic Parts

Polyoxymethylene POM

Operating Temperature Range

-25°C – 70°C

Ambient Humidity Non-Condensing

10% -90%

Gross Weight

11.86kg

Packaging Dimensions

760mm x 590mm x 50mm WxDxH

HS-Code

8544 7000

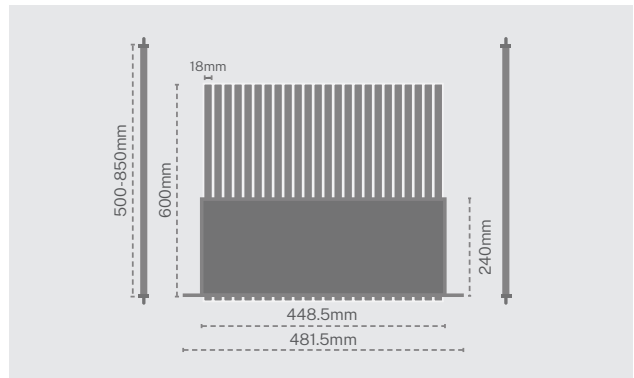
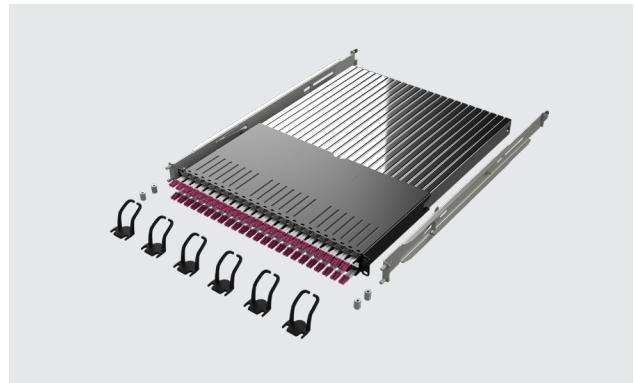

Items included

- 24 x PATCHBOX Plus+ Fiber OS2 / OM4 Cassette with LC-LC / LC-SC connector
- 1 x PATCHBOX Plus+ Frame
- 6 x Patchcatch
- 2 x adjustable mounting rails incl. hex nuts
- 2 x DIN A5 tear-off ID Labels (96 Labels)

OS2 Variants

Product Code	Connector Type
P60SMAOS21124Y	LC-LC
P60SMAOS21224Y	LC-SC

OM4 Variants

Product Code	Connector Type
P60MMAOM41124E	LC-LC
P60MMAOM41224E	LC-SC



PATCHBOX® 365 System STP / UTP

The PATCHBOX® is the most modern cabling system for network cabinets. It makes conventional cable guides and patch cables simply look old. Thousands of satisfied customers worldwide rely on this patented innovation to make their IT more efficient, faster and more economical.

Technical Specification

STP Cable

Flat Cat.6a Shielded Twisted Pair, ISO/IEC 11801 Channel Class Ea, 500MHz, AWG36, 100% stranded copper, PVC jacket, PoE (802.3af)

UTP Cable

Flat Cat.6a Unshielded Twisted Pair, ISO/IEC 11801 Channel Class Ea, 500MHz, AWG30, 100% stranded copper, PVC jacket, PoE (802.3af)

Connector

RJ45 shielded plug, pins gold plated, snagless booted

Cable length

0.8m covers 8RU

Frame

RAL9005 powder coated steel

Cassette Profiles

Stainless steel, laser-welded

Plastic Parts

Polyoxymethylene POM

Operating Temperature Range

-20°C – 60°C

Ambient Humidity Non-Condensing

10% -90%

Gross Weight

8.80kg

Packaging Dimensions

760mm x 590mm x 50mm WxDxH

HS-Code

8544 4210

For Customers in Australia & New Zealand

STP patch cords are compliant with AS/CA S008:2010 A1:2014

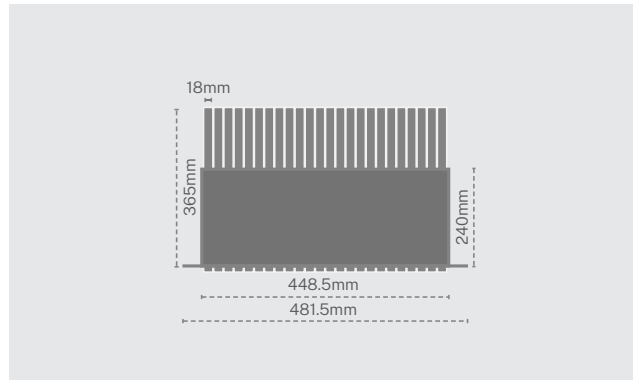
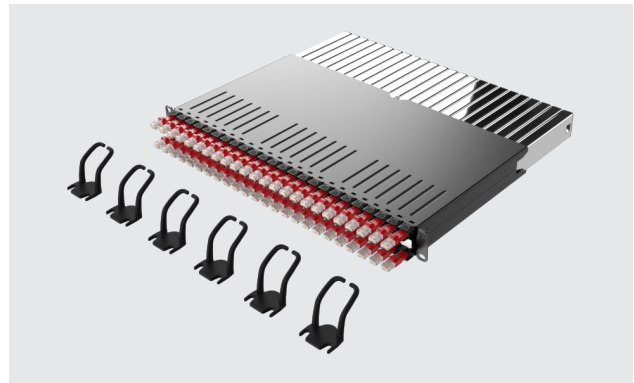

Items included

- 24 x PATCHBOX 365 STP / UTP Cassette with Cat.6a cable
- 1 x PATCHBOX 365 Frame
- 6 x Patchcatch
- 2 x DIN A5 tear-off ID Labels (96 Labels)

Shielded Twisted Pair (STP) Variants

Product Code	Cable Color
P36STPXC6AX24K	Black
P36STPXC6AX24B	Blue
P36STPXC6AX24G	Green
P36STPXC6AX24R	Red
P36STPXC6AX24W	White
P36STPXC6AX24Y	Yellow
P36STPXC6A24GY	Grey
P36STPXC6AX24V	Violet

Unshielded Twisted Pair (UTP) Variants

Product Code	Cable Color
P36UTPXC6AX24K	Black
P36UTPXC6AX24B	Blue
P36UTPXC6AX24G	Green
P36UTPXC6AX24R	Red
P36UTPXC6AX24W	White
P36UTPXC6AX24Y	Yellow
P36UTPXC6AX24V	Violet



PATCHBOX® Plus+ Cassettes Fiber Optic

The PATCHBOX® is the most modern cabling system for network cabinets. It makes conventional cable guides and patch cables simply look old. Thousands of satisfied customers worldwide rely on this patented innovation to make their IT more efficient, faster and more economical.

Technical Specification

OS2 Cable

OS2 RBS 9µ/125µ, G.657.B3, LSZH, Yellow, Single-Mode

OM4 Cable

OM4 RBS 50µ/125µ, LSZH, Erika Violet, Multi-Mode

Connector

LC Duplex - LC Duplex / LC Duplex - SC Duplex

Cable length

1.8m covers 30RU

Cassette Profiles

Stainless steel, laser-welded

Plastic Parts

Polyoxymethylene POM

Operating Temperature Range

-25°C – 70°C

Ambient Humidity Non-Condensing

10% -90%

Gross Weight

0.40kg

Packaging Dimensions

690mm x 50mm x 50mm WxDxH

HS-Code

8544 7000

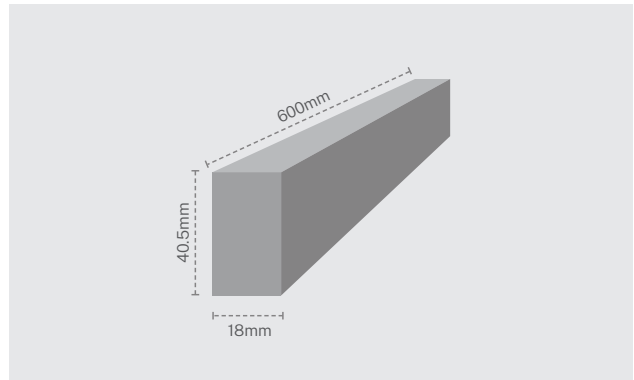

Items included

1 x PATCHBOX Plus+ Fiber OS2 / OM4 Cassette
with LC-LC / LC-SC connector

OS2 Variants

PRODUCT CODE	Connector Type
C60SMAOS211X1Y	LC-LC
C60SMAOS212X1Y	LC-SC

OM4 Variants

Product Code	Connector Type
C60MMAOM411X1E	LC-LC
C60MMAOM412X1E	LC-SC



PATCHBOX® Plus+ Long Range Cassettes Fiber Optic

The PATCHBOX® is the most modern cabling system for network cabinets. It makes conventional cable guides and patch cables simply look old. Thousands of satisfied customers worldwide rely on this patented innovation to make their IT more efficient, faster and more economical.

Technical Specification

OS2 Cable

OS2 RBS 9μ/125μ, G.657.B3, LSZH, Yellow, Single-Mode

OM4 Cable

OM4 RBS 50μ/125μ, LSZH, Erika Violet, Multi-Mode

Connector

LC Duplex - LC Duplex / LC Duplex - SC Duplex

Cable length

2.5m cover 46 RU:

1.8m extractable + 0.7m overlength non-retractable

Cassette Profiles

Stainless steel, laser-welded

Plastic Parts

Polyoxymethylene POM

Operating Temperature Range

-25°C – 70°C

Ambient Humidity Non-Condensing

10% -90%

Gross Weight

0.42kg

Packaging Dimensions

690mm x 50mm x 50mm WxDxH

HS-Code

8544 7000

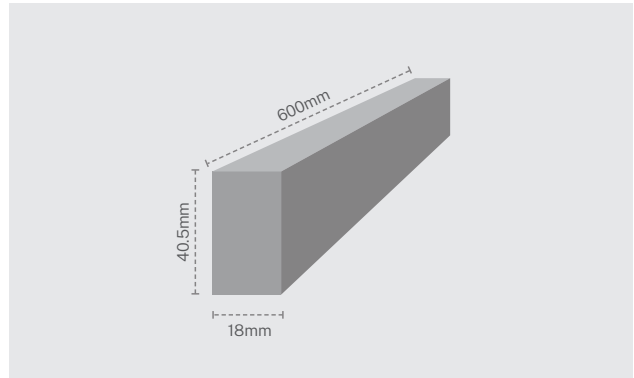
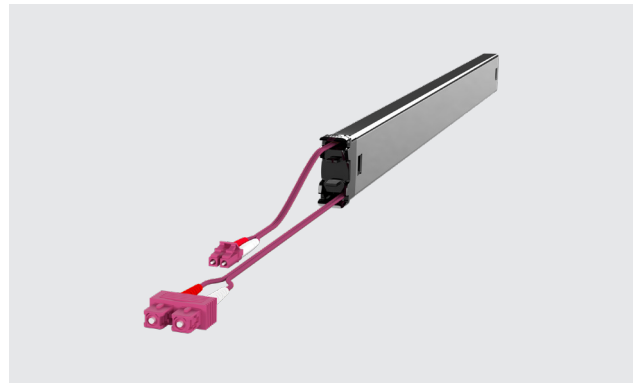

Items included

1 x PATCHBOX Plus+ Fiber Optic OS2 / OM4 Long Range

Cassette with LC-LC / LC-SC connector

OS2 Variants

Product Code

C60SMAOS21131Y

C60SMAOS21231Y

Connector Type

LC-LC

LC-SC

OM4 Variants

Product Code

C60MMAOM41131E

C60MMAOM41231E

Connector Type

LC-LC

LC-SC



PATCHBOX® Plus+ Cassettes STP / UTP

The PATCHBOX® is the most modern cabling system for network cabinets. It makes conventional cable guides and patch cables simply look old. Thousands of satisfied customers worldwide rely on this patented innovation to make their IT more efficient, faster and more economical.

Technical Specification

STP Cable

Flat Cat.6a Shielded Twisted Pair, ISO/IEC 11801 Channel Class Ea, 500MHz, AWG36, 100% stranded copper, PVC jacket, PoE (802.3af)

UTP Cable

Flat Cat.6a Unshielded Twisted Pair, ISO/IEC 11801 Channel Class Ea, 500MHz, AWG30, 100% stranded copper, PVC jacket, PoE (802.3af)

Connector

RJ45 shielded plug, pins gold plated, snagless booted

Cable length

1.8m covers 30RU

Cassette Profiles

Stainless steel, laser-welded

Plastic Parts

Polyoxymethylene POM

Operating Temperature Range

-520°C – 60°C

Ambient Humidity Non-Condensing

10% -90%

Gross Weight

0.40kg

Packaging Dimensions

690mm x 50mm x 50mm WxDxH

HS-Code

8544 4210

For Customers in Australia & New Zealand

STP patch cords are compliant with AS/CA S008:2010 A1:2014

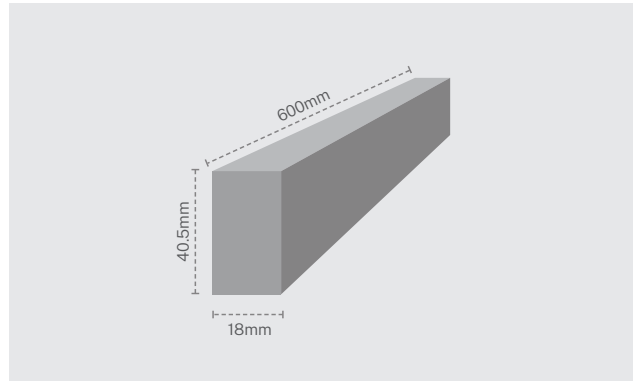

Items included

1 x PATCHBOX Plus+ STP / UTP Cassette with Cat.6a cable

Shielded Twisted Pair (STP) Variants

Product Code	Cable Color
C60STPXC6AXX1K	Black
C60STPXC6AXX1B	Blue
C60STPXC6AXX1G	Green
C60STPXC6AXX1R	Red
C60STPXC6AXX1W	White
C60STPXC6AXX1Y	Yellow
C60STPXC6AX1GY	Grey
C60STPXC6AXX1V	Violet

Unshielded Twisted Pair (UTP) Variants

Product Code	Cable Color
C60UTPXC6AXX1K	Black
C60UTPXC6AXX1B	Blue
C60UTPXC6AXX1G	Green
C60UTPXC6AXX1R	Red
C60UTPXC6AXX1W	White
C60UTPXC6AXX1Y	Yellow
P60UTPXC6AX24V	Violet





PATCHBOX® Plus+ Long Range Cassettes - STP / UTP

The PATCHBOX® is the most modern cabling system for network cabinets. It makes conventional cable guides and patch cables simply look old. Thousands of satisfied customers worldwide rely on this patented innovation to make their IT more efficient, faster and more economical.

Technical Specification

STP Cable

Flat Cat.6a Shielded Twisted Pair, ISO/IEC 11801 Channel Class Ea, 500MHz, AWG36, 100% stranded copper, PVC jacket, PoE (802.3af)

UTP Cable

Flat Cat.6a Unshielded Twisted Pair, ISO/IEC 11801 Channel Class Ea, 500MHz, AWG30, 100% stranded copper, PVC jacket, PoE (802.3af)

Connector

RJ45 shielded plug, pins gold plated, snagless booted

Cable length

2.5m cover 46 RU:

1.8m extractable + 0.7m overlength non-retractable

Cassette Profiles

Stainless steel, laser-welded

Plastic Parts

Polyoxymethylene POM

Operating Temperature Range

-20°C – 60°C

Ambient Humidity Non-Condensing

10% -90%

Gross Weight

0.42kg

Packaging Dimensions

690mm x 50mm x 50mm WxDxH

HS-Code

8544 4210

For Customers in Australia & New Zealand

STP patch cords are compliant with AS/CA S008:2010 A1:2014

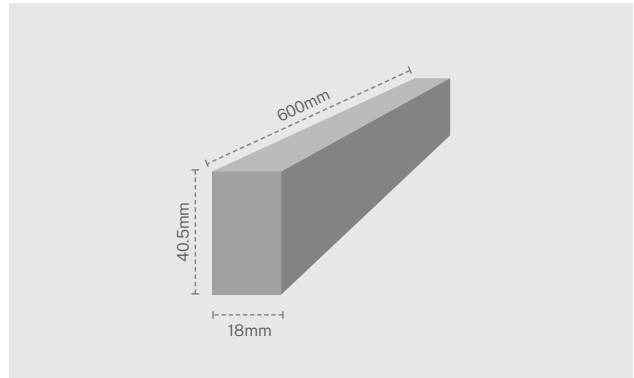

Items included

1 x PATCHBOX Plus+ STP / UTP Long Range Cassette with Cat.6a cable

Shielded Twisted Pair (STP) Variants

Product Code	Cable Color
C60STPXC6AX31K	Black
C60STPXC6AX31B	Blue
C60STPXC6AX31G	Green
C60STPXC6AX31R	Red
C60STPXC6AX31W	White
C60STPXC6AX31Y	Yellow
C60STPXC6A31GY	Grey
C60STPXC6AX31V	Violet

Unshielded Twisted Pair (UTP) Variants

Product Code	Cable Color
C60UTPXC6AX31K	Black
C60UTPXC6AX31B	Blue
C60UTPXC6AX31G	Green
C60UTPXC6AX31R	Red
C60UTPXC6AX31W	White
C60UTPXC6AX31Y	Yellow
C60UTPXC6AX31V	Violet



PATCHBOX® 365 Cassettes STP / UTP

The PATCHBOX® is the most modern cabling system for network cabinets. It makes conventional cable guides and patch cables simply look old. Thousands of satisfied customers worldwide rely on this patented innovation to make their IT more efficient, faster and more economical.

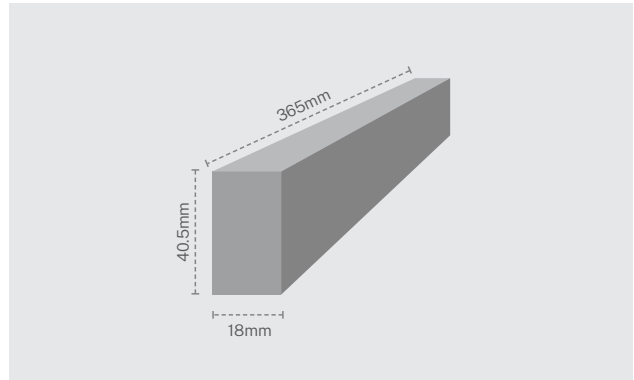
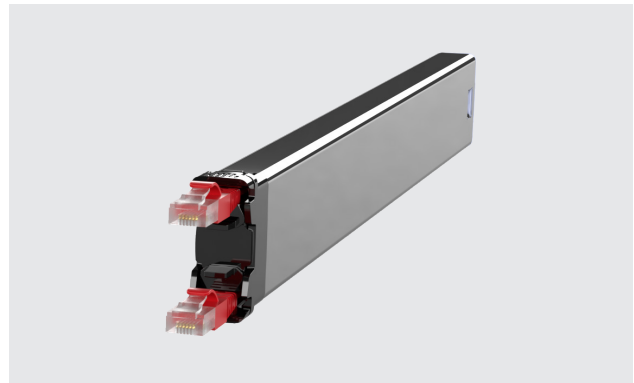

Technical Specification

STP Cable

Flat Cat.6a Shielded Twisted Pair, ISO/IEC 11801 Channel Class Ea, 500MHz, AWG36, 100% stranded copper, PVC jacket, PoE (802.3af)

UTP Cable

Flat Cat.6a Unshielded Twisted Pair, ISO/IEC 11801 Channel Class Ea, 500MHz, AWG30, 100% stranded copper, PVC jacket, PoE (802.3af)

Connector

RJ45 shielded plug, pins gold plated, snagless booted

Cable length

0.8m covers 8RU

Cassette Profiles

Stainless steel, laser-welded

Plastic Parts

Polyoxymethylene POM

Operating Temperature Range

-20°C – 60°C

Ambient Humidity Non-Condensing

10% -90%

Gross Weight

0.40kg

Packaging Dimensions

690mm x 50mm x 50mm WxDxH

HS-Code

8544 4210

For Customers in Australia & New Zealand

STP patch cords are compliant with AS/CA S008:2010 A1:2014

Items included

1 x PATCHBOX 365 STP / UTP Cassette with Cat.6a cable

Shielded Twisted Pair (STP) Variants

Product Code	Cable Color
C36STPXC6AAX1K	Black
C36STPXC6AAX1B	Blue
C36STPXC6AAX1G	Green
C36STPXC6AAX1R	Red
C36STPXC6AAX1W	White
C36STPXC6AAX1Y	Yellow
C36STPXC6AAX1GY	Grey

Unshielded Twisted Pair (UTP) Variants

Product Code	Cable Color
C36UTPXC6AAX1K	Black
C36UTPXC6AAX1B	Blue
C36UTPXC6AAX1G	Green
C36UTPXC6AAX1R	Red
C36UTPXC6AAX1W	White
C36UTPXC6AAX1Y	Yellow
C36UTPXC6AAX1V	Violet



PATCHBOX® 365 Cassettes Fiber Optic

The PATCHBOX® is the most modern cabling system for network cabinets. It makes conventional cable guides and patch cables simply look old. Thousands of satisfied customers worldwide rely on this patented innovation to make their IT more efficient, faster and more economical.

Technical Specification

OS2 Cable

OS2 RBS 9µ/125µ, G.657.B3, LSZH, Yellow, Single-Mode

OM4 Cable

OM4 RBS 50µ/125µ, LSZH, Erika Violet, Multi-Mode

Connector

LC Duplex - LC Duplex / LC Duplex - SC Duplex

Cable length

0.8m covers 8RU

Cassette Profiles

Stainless steel, laser-welded

Plastic Parts

Polyoxymethylene POM

Operating Temperature Range

-25°C – 70°C

Ambient Humidity Non-Condensing

10% -90%

Gross Weight

0.40kg

Packaging Dimensions

690mm x 50mm x 50mm WxDxH

HS-Code

8544 7000

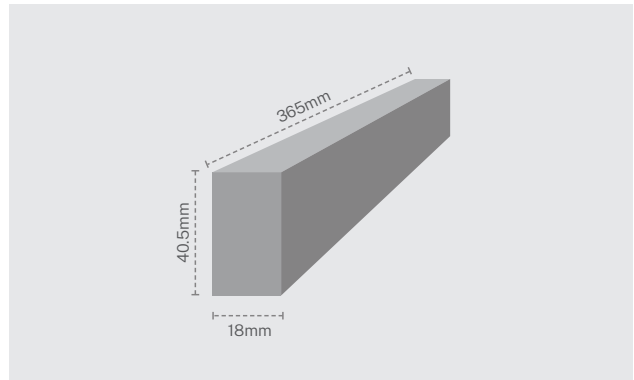

Items included

1 x PATCHBOX 365 Fiber OS2 / OM4 Cassette
with LC-LC / LC-SC connector

OS2 Variants

PRODUCT CODE	Connector Type
C36SMAOS211X1Y	LC-LC
C36SMAOS212X1Y	LC-SC

OM4 Variants

Product Code	Connector Type
C36MMAOM411X1E	LC-LC
C36MMAOM412X1E	LC-SC



PATCHBOX® Plus+ Frame

The PATCHBOX® is the most modern cabling system for network cabinets. It makes conventional cable guides and patch cables simply look old. Thousands of satisfied customers worldwide rely on this patented innovation to make their IT more efficient, faster and more economical.

Technical Specification

Frame

RAL9005 powder coated steel

Plastic Parts

Polyoxymethylene POM

Gross Weight

4.20kg

Mounting Rails

Stainless steel, variable from 500mm to 850mm

Operating Temperature Range

-10°C – 60°C

Ambient Humidity Non-Condensing

10% -90%

Packaging Dimensions

760mm x 590mm x 50mm WxDxH

HS-Code

8538 9099

Country of Origin

Thailand

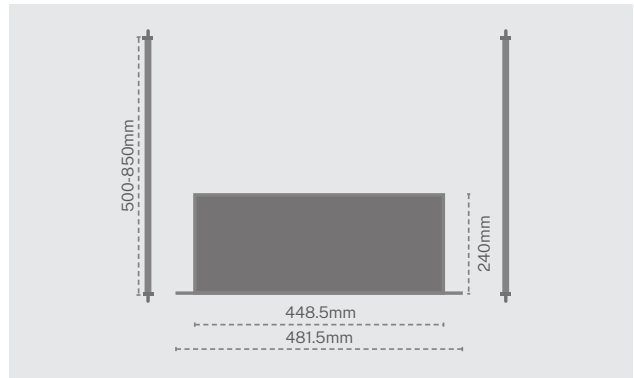
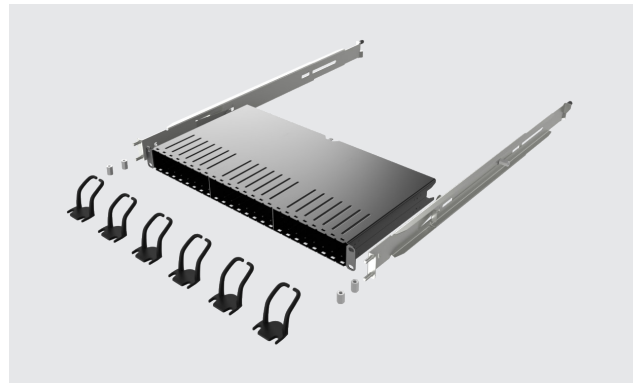

Items included

- 1 x PATCHBOX Plus+ Frame
- 2 x Mounting rails incl. hex nuts
- 6 x Patchcatch
- 2 x DIN A5 tear-off ID Labels (96 Labels)

Product Code

PBXFRAME



PATCHBOX® 365 Frame

The PATCHBOX® is the most modern cabling system for network cabinets. It makes conventional cable guides and patch cables simply look old. Thousands of satisfied customers worldwide rely on this patented innovation to make their IT more efficient, faster and more economical.

Technical Specification

Frame

RAL9005 powder coated steel

Plastic Parts

Polyoxymethylene POM

Gross Weight

3.15kg

Operating Temperature Range

-10°C – 60°C

Ambient Humidity Non-Condensing

10% -90%

Packaging Dimensions

760mm x 590mm x 50mm WxDxH

HS-Code

8538 9099

Country of Origin

Thailand

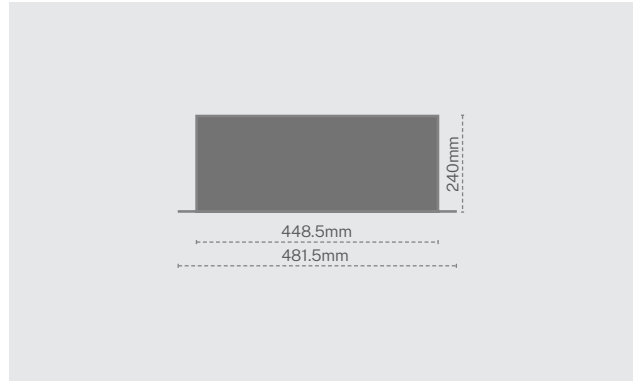
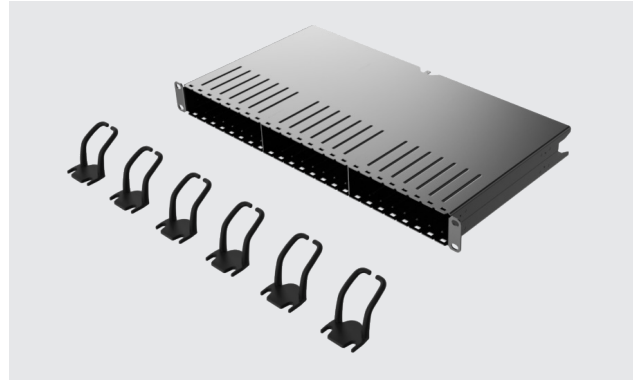

Items included

1 x PATCHBOX 365 Frame

6 x Patchcatch

2 x DIN A5 tear-off ID Labels (96 Labels)

Product Code

PBXFRAME365



PATCHBOX® Setup.exe

The Setup.exe enables one technician to do the job of two. The Setup.exe secures the weight of equipment, such as switches, in server and network racks until they are securely screwed in. Mounted inside out of a rack the Setup.exe creates the ideal workspace to place a laptop during configuration or terminating a patch panel.



Technical Specification

Dimension Folded

465mm x 53.5mm x 45mm WxDxH

Materials

Aluminium, stainless steel, powder coated steel

Gross Weight

0.88kg

Max. load weight

50kg (110lb)

Packaging Dimensions

510mm x 600mm x 55mm WxDxH

HS-Code

8205 5980

Items included

1 x Setup.exe

Product Code

PBXEXE

YEARS OF
WARRANTY **LIFETIME**

MADE
IN THE **EU**

PATCHBOX® Patchcatch

Our innovative cable organizer with zero rack units – the Patchcatch ORU – can simply be mounted under the mounting brackets of switches and patch panels. Compared to conventional horizontal cable management it does not take any additional space in a network cabinet. All patch cords – Cat.6a and fibre optic – are guided to the side of the RU and are patched to keep the cabinet nice and tidy.

Technical Specification

Plastic Parts

Polyoxymethylene POM

Operating Temperature Range

-10°C – 60°C

Ambient Humidity Non-Condensing

10% -90%

Gross Weight

0.06kg

Packaging Dimensions

100mm x 95mm x 40mm WxDxH

HS-Code

3926 9097

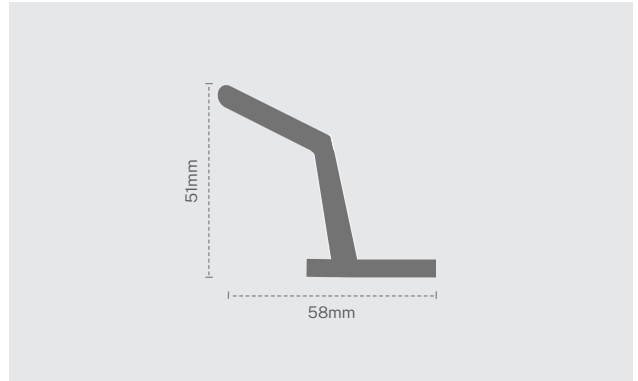

Items included

4 x Patchcatch

Product Code

PBCX8K



PATCHBOX® ID Labels

The ID Labels are simply slid onto the cable stopper on the Cassette. When the PATCHBOX® is mounted above or underneath a switch you already have a logical assignment of the Cassettes to the switch ports. With the patch panel port written on the ID Label you see all your connections immediately.

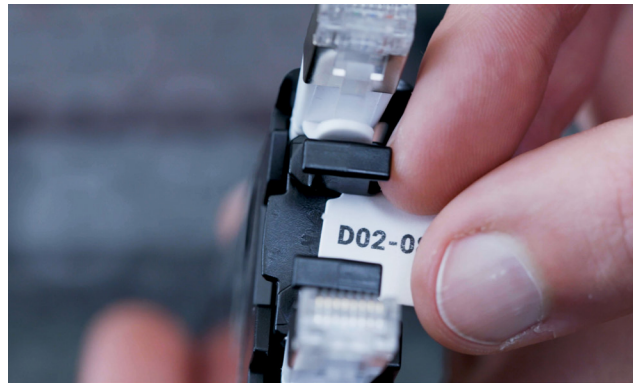

Technical Specification

Weight

0.02kg

Packaging Dimensions

250mm x 160mm x 10mm WxDxH

HS-Code

4802 5890

Country of Origin

China

Items included

2 x DIN A5 tear-off ID Labels (96 Labels)

Product Code

IDLABELW

PATCHBOX® Blind Panel

The Blind Panels can be used to cover up unused slots from your PATCHBOX®. This ensures air circulation within your cabinet remains optimised and keeps cool what needs to be cool. Simply clip them into the frame and reuse them anytime in another slot.



Technical Specification

Plastic Parts

Polyoxymethylene POM

Operating Temperature Range

-10°C – 60°C

Ambient Humidity Non-Condensing

10% -90%

Gross Weight

0.06kg

Packaging Dimensions

100mm x 95mm x 40mm WxDxH

HS-Code

3926 9097

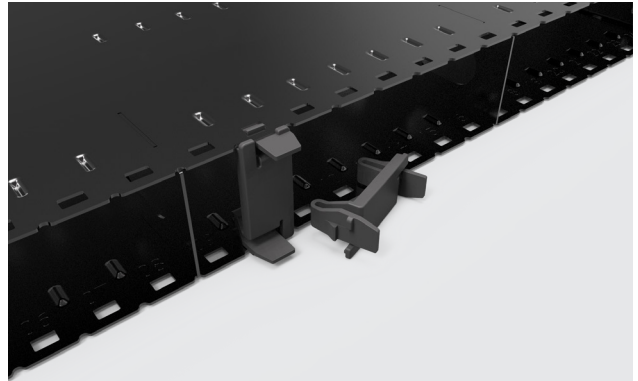

Items included

10 x Blind Panels

Product Code

PBXBLIND



PATCHBOX® /dev/mount

The /dev/mount is the fastest solution replacing conventional cage nuts used in server and network racks. Its faster mounting capabilities increases productivity of mounting 19" equipment. The /dev/mount holds equipment securely in place before the nuts are fastened, making hardware mounting a faster and more secure task.



Technical Specification

Profile

Spring steel / aluminium

Weight

1.33kg

Packaging Dimensions

235mm x 155mm x 70mm WxDxH

HS-Code

7318 1900

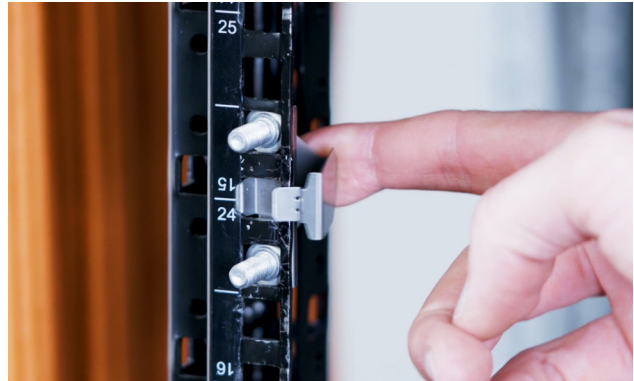

Compatibility with 19" rails

The /dev/mount is compatible with 19" rails with square punched holes that are capable of installing standard standard server rails.

Items included

- 50 x /dev/mount
- 100 x dual-sided / reversible hex nuts

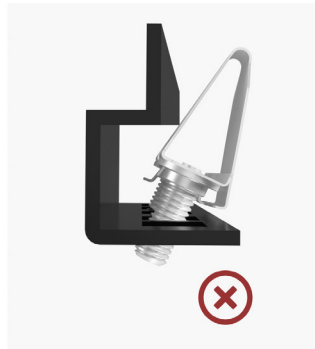

Product Code

DVMNT50

No tools necessary. Tightening the hex nuts by hand is quite sufficient.

